

1
Panel Connection

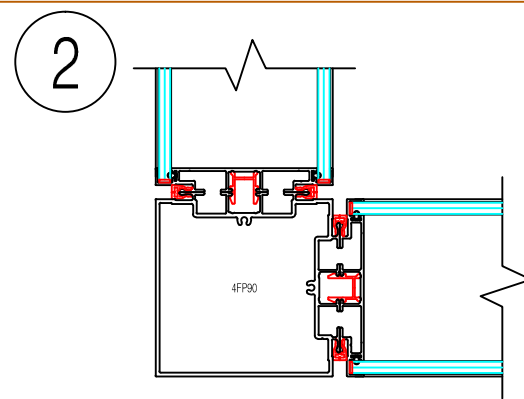

2
2-Way Post

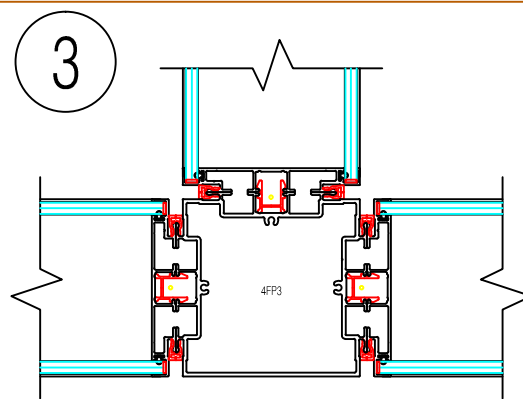

3
3-Way Post

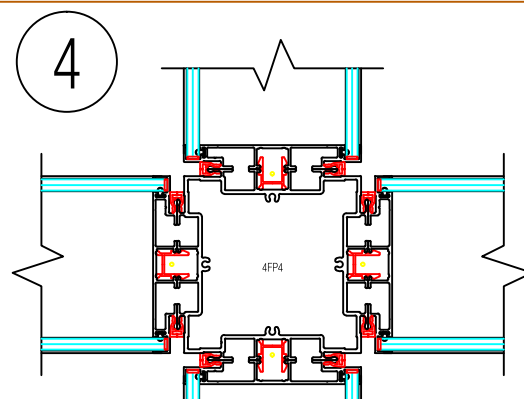

4
4-Way Post

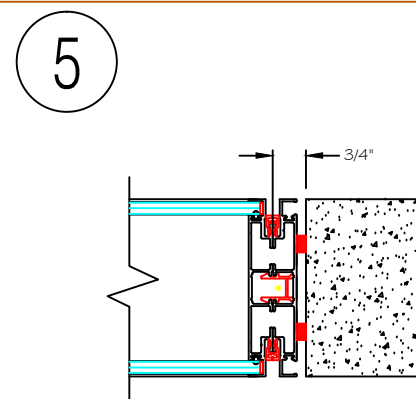

5
Flush Wall Start

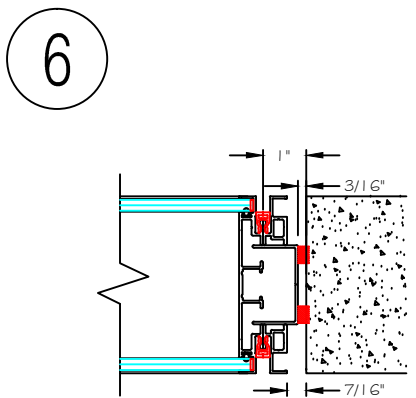

6
Recessed Wall Start

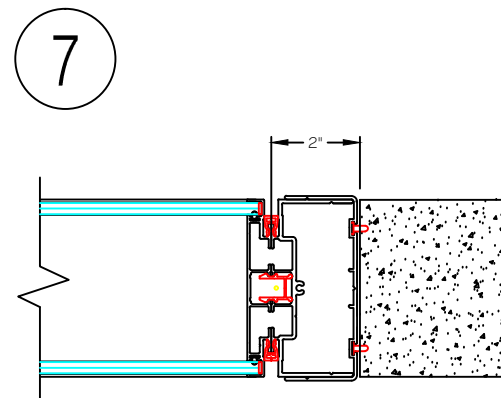

7
2" Mini-End

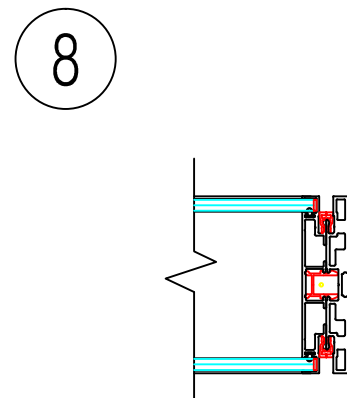

8
Finished End

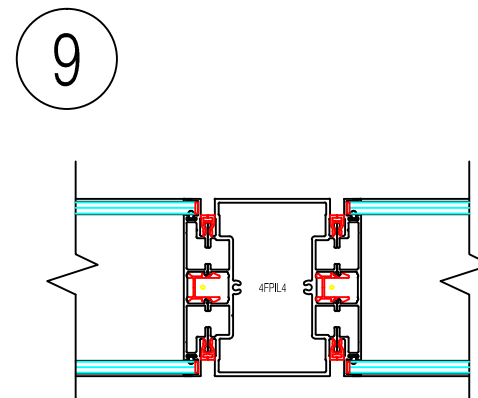

9
3" In-Line Post

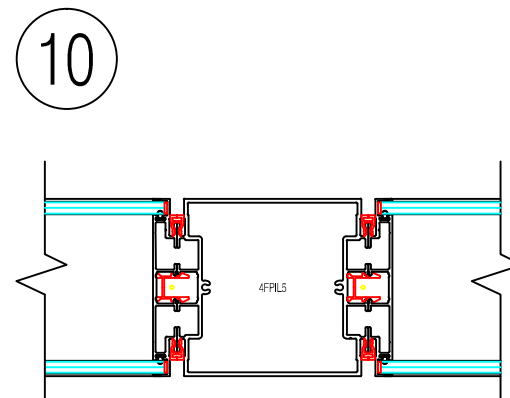

10
4" In-Line Post

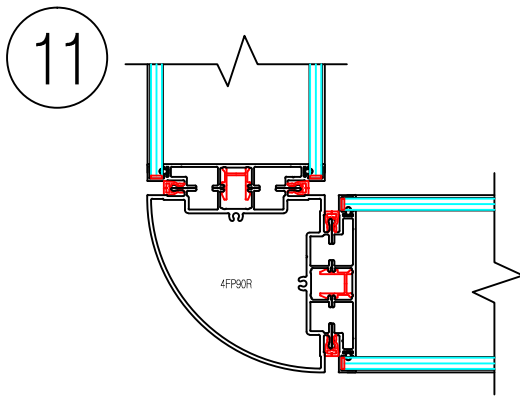

11
Radius 2-Way Post

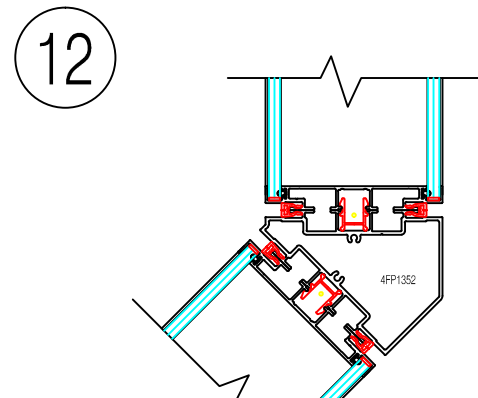

12
135 Degree Post

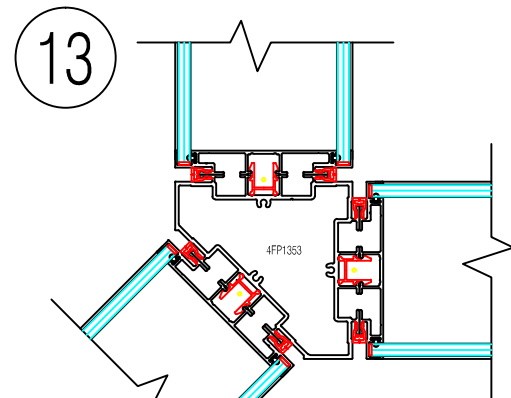

13
135 Degree 3-Way Post

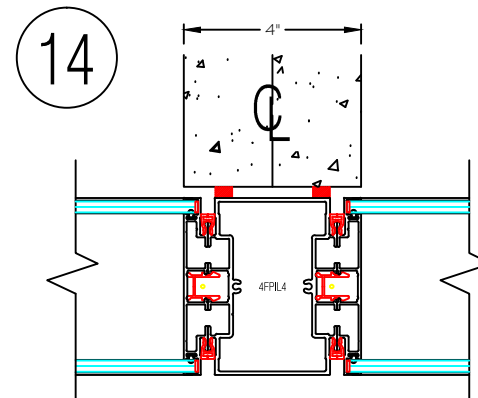

14
3" In-Line Post at
4" Drywall Bypass

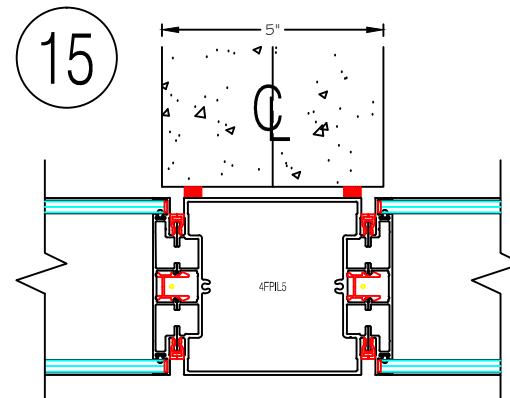

15
4" In-Line Post at
5" Drywall Bypass

Please note: these shop drawings supercede any other reference to dimensions and represent the final dimensions to be used for production. Signing off indicates that these dimensions accurately represent (or will through hold to dimensions) actual field conditions. Whomever signs off on the end users behalf assumes full responsibility for their accuracy.

This Document is the property and copyright of Infinium Architectural Wall Systems, Inc. and shall not be reproduced without written consent of Infinium Architectural Wall Systems, Inc. This drawing is to be used for evaluation, bidding, or furniture installation only and should not be used for building construction.

8		
7		
6		
5		
4		
3		
2		
1		

NO. DATE ISSUE/REVISION

CURRENT REVISION: 0

Refine 2X Horizontal Sections
Details 1 thru 15

DRAWING TITLE:
Refine 2X Horizontal Sections

DATE:

SCALE:

AREA:

PROJECT NO:

PROJECT LEADER:

CAD DRAFTER:

CHECKED BY:

CAD FILE NAME:

DRAWING NO:

1

SHEET NO:

1 of 3