

16

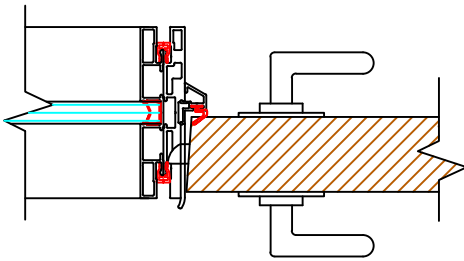

Panel to DF Keeper
Wood Door

17

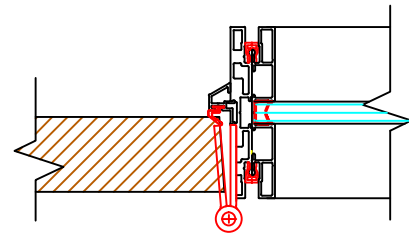

Panel to DF Hinge
Wood Door

18

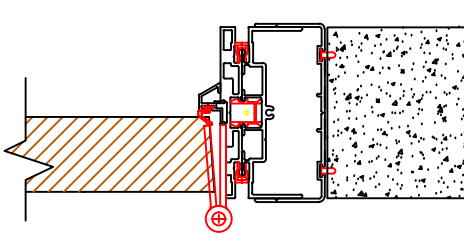

DF @ 2" Mini-End
Wood Door

19

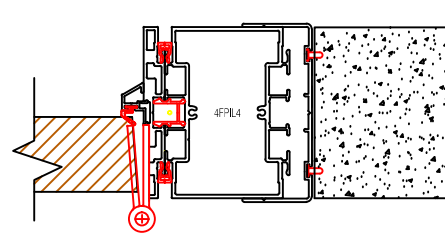

DF @ 3.5" Mini-End
Wood Door

20

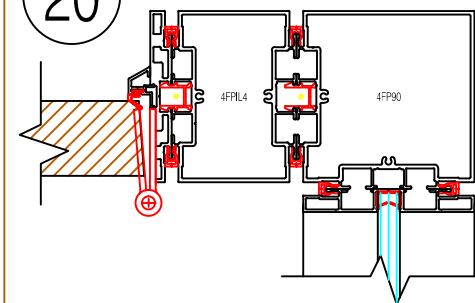

DF @ Post
90 Degree Swing
Wood Door

21

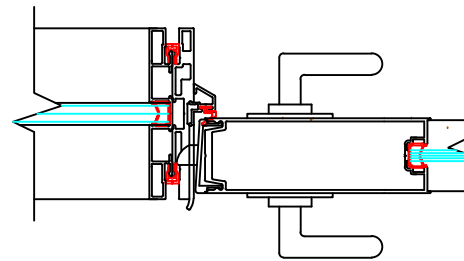

Panel to DF Keeper
Aluminum Door

22

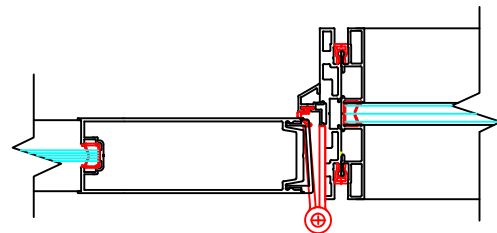

Panel to DF Hinge
Aluminum Door

23

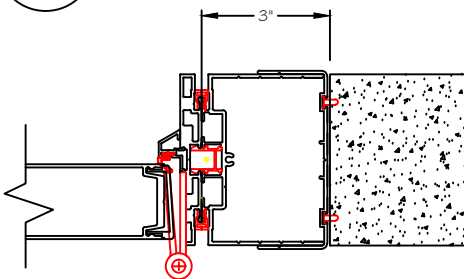

DF @ 3" Mini-End
Aluminum Door

24

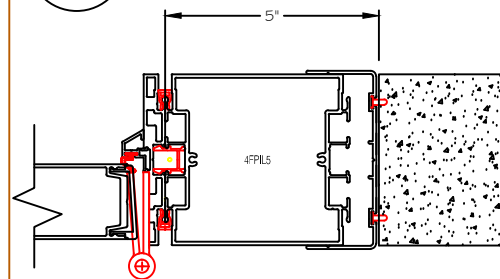

DF @ 5" Mini-End
Aluminum Door

25

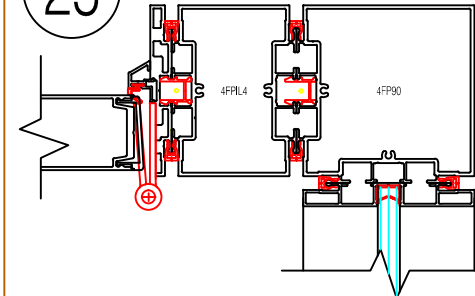

DF @ Post
90 Degree Swing
Aluminum Door

26

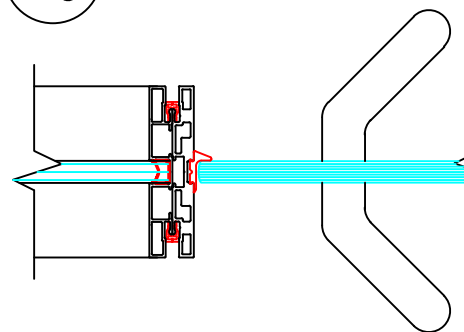

Panel to Center Pivot
Glass Door @ Keeper

27

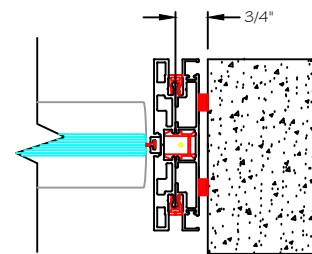

Center Pivot Glass
Door @ Flush WS

28

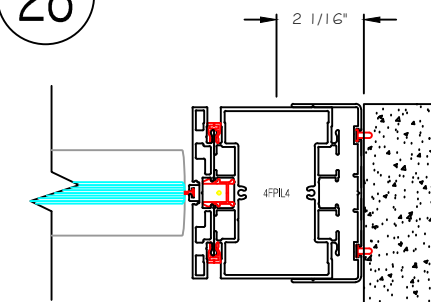

Center Pivot Glass
Door @ 3.5" ME

29

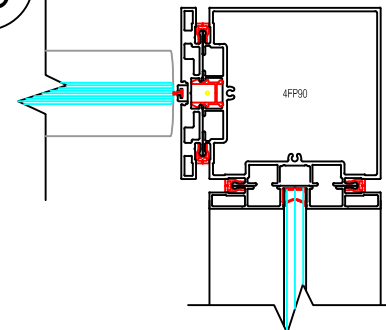

Center Pivot Glass
Door @ 2-Way Post

30

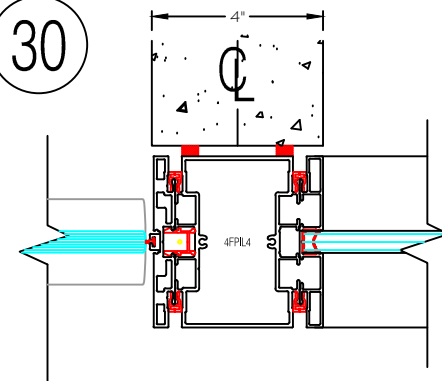

Center Pivot Glass
Door @ In-Line Post

Please note: these shop drawings supercede any other reference to dimensions and represent the final dimensions to be used for production. Signing off indicates that these dimensions accurately represent (or will through hold to dimensions) actual field conditions. Whomever signs off on the end users behalf assumes full responsibility for their accuracy.



6749 Eastland Road, Suite B
Middleburg Heights, OH 44130
PH 440-239-9000 FX 440-239-9002

This Document is the property and copyright of Infinium Architectural Wall Systems, Inc. and shall not be reproduced without written consent of Infinium Architectural Wall Systems, Inc. This drawing is to be used for evaluation, bidding, or furniture installation only and should not be used for building construction.

8	
7	
6	
5	
4	
3	
2	
1	

NO. DATE ISSUE/REVISION

0

CURRENT REVISION:

Refine 1X Horizontal Sections
Details 16 thru 30

DRAWING TITLE:

Refine
1X Horizontal Sections

DATE:

SCALE:

AREA:

PROJECT NO.:

PROJECT LEADER:

CAD DRAFTER:

CHECKED BY:

CAD FILE NAME:

DRAWING NO.:

2

SHEET NO.:

2 of 3