

31
Panel to Center Pivot Wood Door @ Keeper

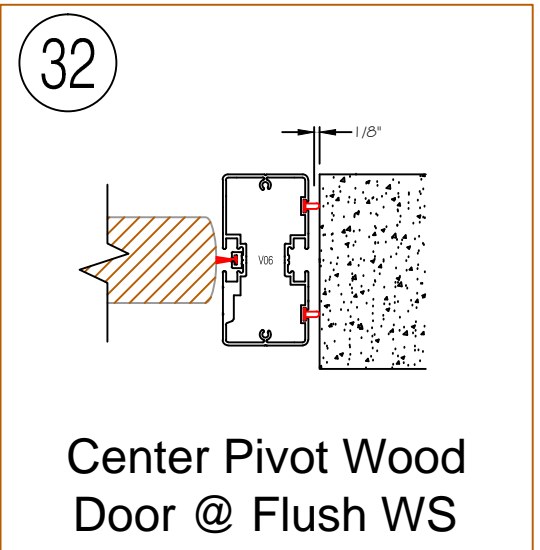

32
Center Pivot Wood Door @ Flush WS

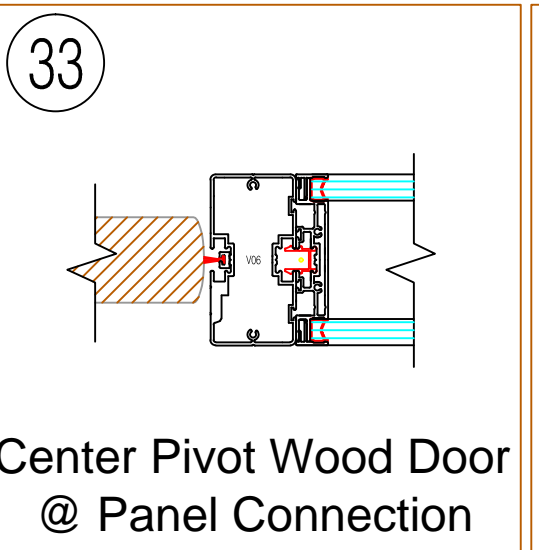

33
Center Pivot Wood Door @ Panel Connection

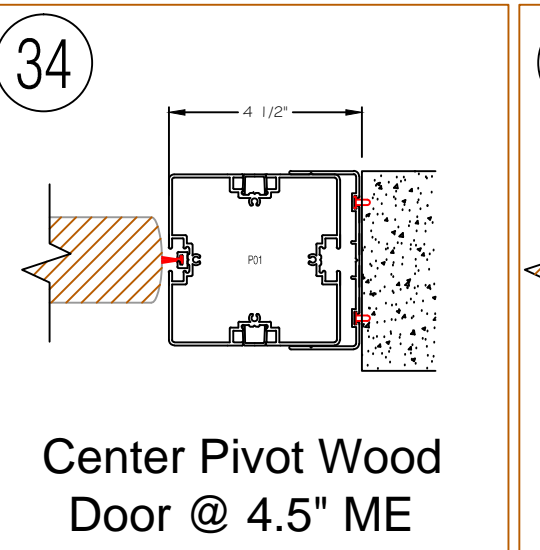

34
Center Pivot Wood Door @ 4.5" ME

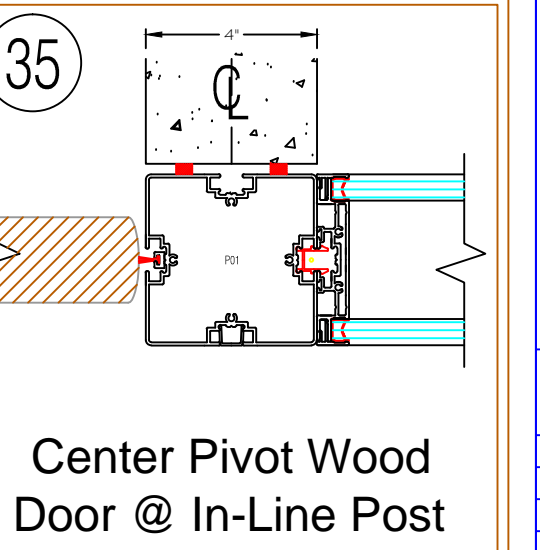

35
Center Pivot Wood Door @ In-Line Post

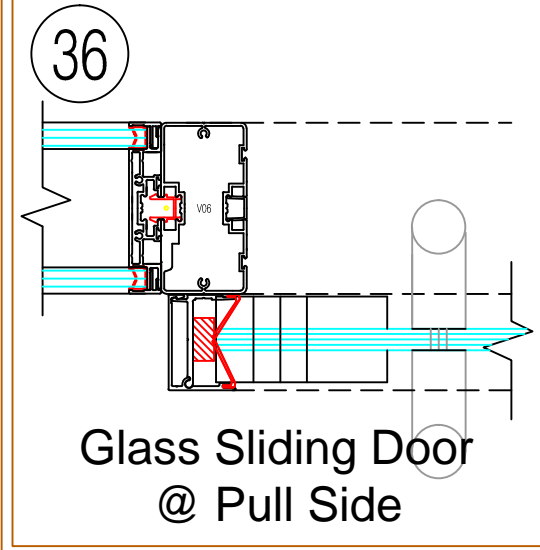

36
Glass Sliding Door @ Pull Side

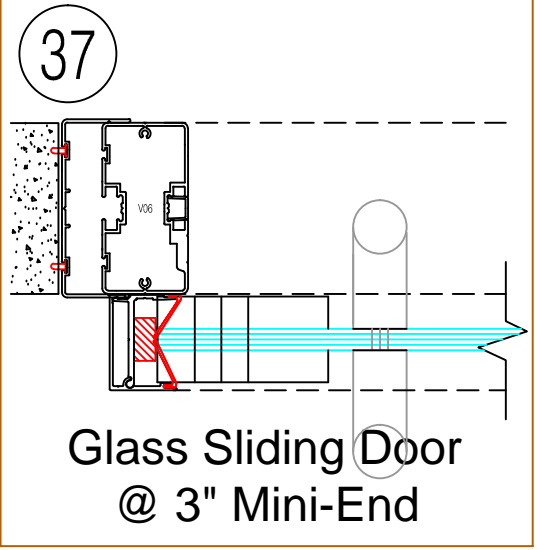

37
Glass Sliding Door @ 3" Mini-End

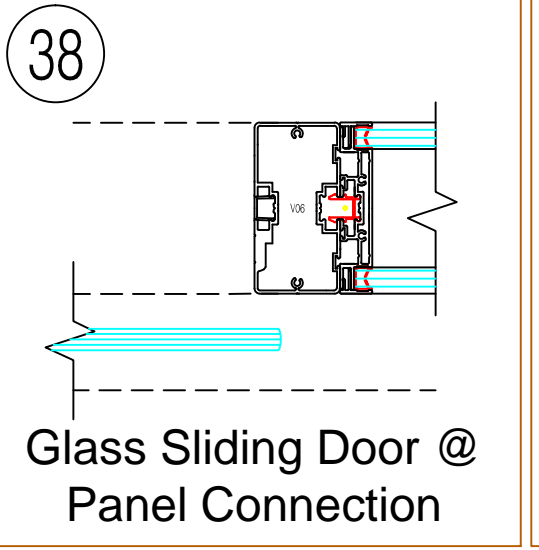

38
Glass Sliding Door @ Panel Connection

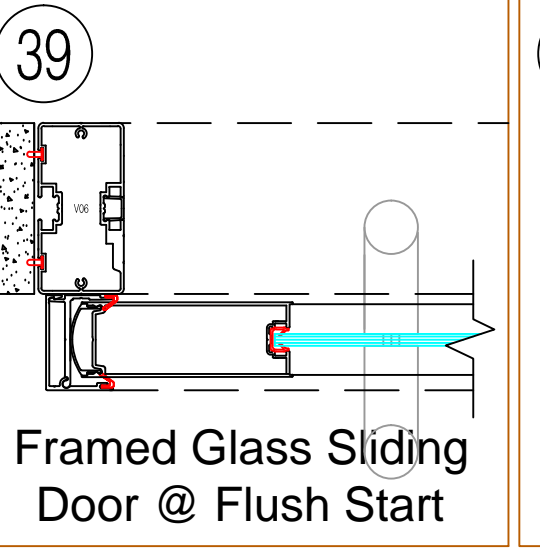

39
Framed Glass Sliding Door @ Flush Start

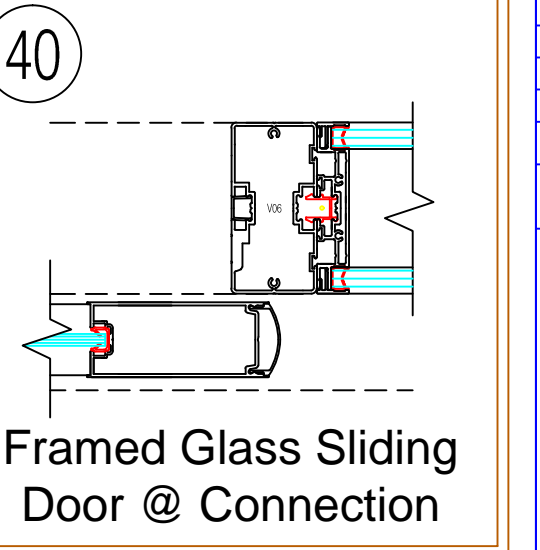

40
Framed Glass Sliding Door @ Connection

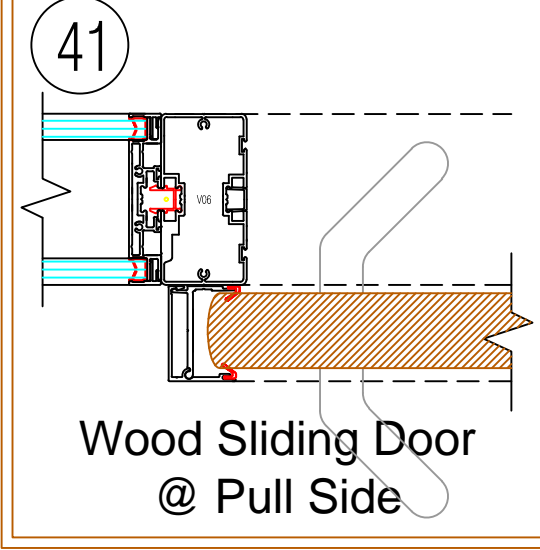

41
Wood Sliding Door @ Pull Side

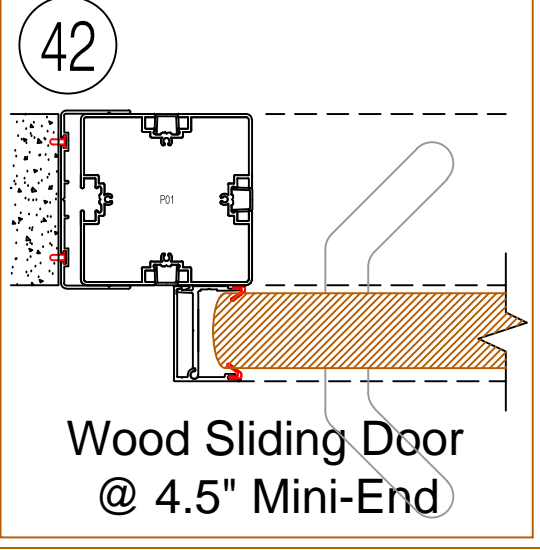

42
Wood Sliding Door @ 4.5" Mini-End

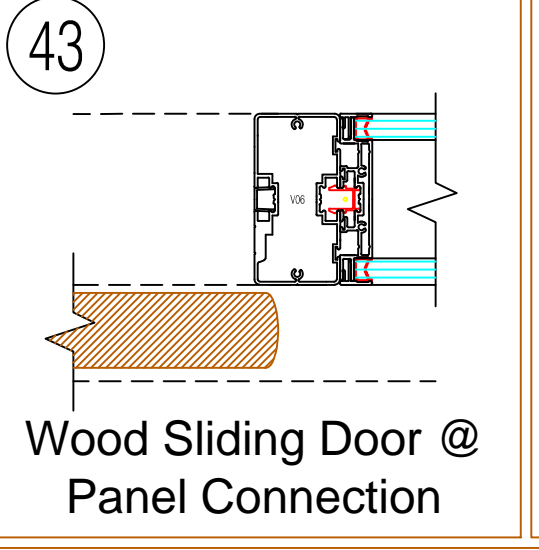

43
Wood Sliding Door @ Panel Connection

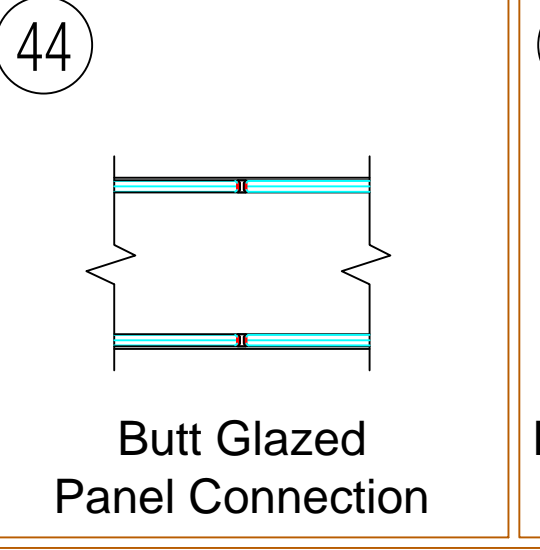

44
Butt Glazed Panel Connection

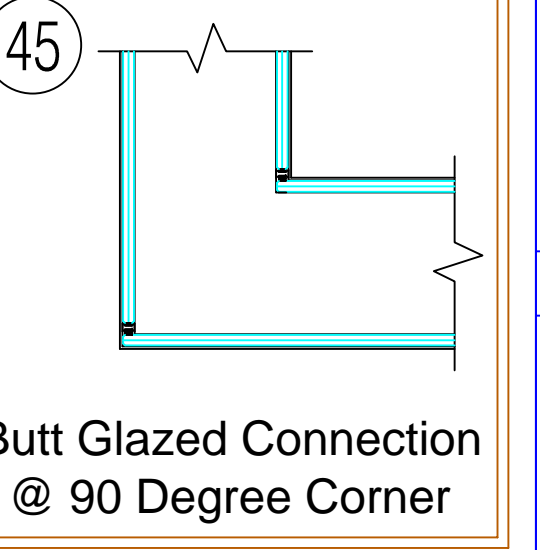

45
Butt Glazed Connection @ 90 Degree Corner

Please note: these shop drawings supercede any other reference to dimensions and represent the final dimensions to be used for production. Signing off indicates that these dimensions accurately represent (or will through hold to dimensions) actual field conditions. Whomever signs off on the end users behalf assumes full responsibility for their accuracy.

INFENILUM
ARCHITECTURAL WALL SYSTEMS

6749 Eastland Road, Suite B
Middleburg Heights, OH 44130
P# 440-239-9000 F# 440-239-9002

This Document is the property and copyright of Infenilum Architectural Wall Systems, Inc. and shall not be reproduced without written consent of Infenilum Architectural Wall Systems, Inc. This drawing is to be used for evaluation, bidding, or furniture installation only and should not be used for building construction.

8	
7	
6	
5	
4	
3	
2	
1	

NO.	DATE	ISSUE/REVISION
0		

NO. DATE ISSUE/REVISION
CURRENT REVISION: 0

Access Horizontal Sections
Details 31 thru 45

DRAWING TITLE: Access Horizontal Sections

DATE:

SCALE:

AREA:

PROJECT NO.:

PROJECT LEADER:

CAD DRAFTER:

CHECKED BY:

CAD FILE NAME:

DRAWING NO. 3

SHEET NO. 3 of 3